

MECHANICAL - HYDRAULIC W20 LOW MOUNT WINCH

A compact, versatile, heavy duty winch. Ideal for application such as:

- Recovery
- Tilt trays and slide backs
- Telecommunications
- Mine Sites
- Logging
- Tractors



PROUDLY MADE IN AUSTRALIA
FULL 2 YEAR WARRANTY

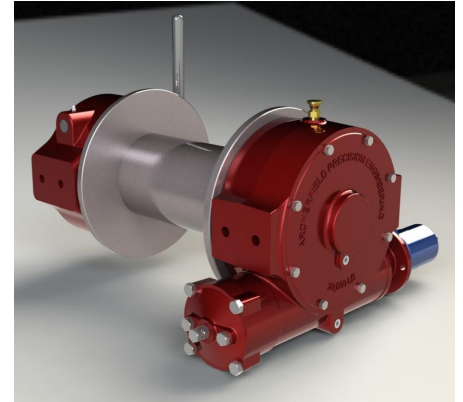

Mechanical or Hydraulic drive.
Can be assembled Right Hand or Left Hand.
Lever operated dog clutch. Large drum diameter for extended rope life.
Drag brake on the drum to prevent wire rope ballooning when freewheeling.
Optional wire rope, wormbrake and various mounting angles are available.
We can produce custom designs if the standard winch just won't do.

SPECIFICATIONS

Capacity: 89.0 kN (20,000 lb)
Weight: 120kg (without rope)
Ratio: 41:1
Rec. Wire Rope: 30m x Ø16mm
Max Wire Rope: 90m x Ø16mm
Hydraulic Oil Requirements
75 litre/min @ 153 bar

| Layer | Line Pull kN | Line Speed @ 75 l/m m/min | Line Speed @ 60 l/m m/min | Total rope Length m |
|-------|-----------------|---------------------------------|---------------------------------|---------------------------|
| 1 | 89.0 | 5.1 | 4.0 | 10.0 |
| 2 | 73.9 | 6.2 | 5.0 | 21.9 |
| 3 | 63.2 | 7.2 | 5.8 | 36.0 |
| 4 | 55.2 | 8.3 | 6.6 | 52.0 |
| 5 | 49.0 | 9.4 | 7.5 | 70.1 |
| 6 | 44.1 | 10.5 | 8.3 | 90.2 |



All our winches feature hardened and ground worms and bronze worm wheels for long service and reliability.

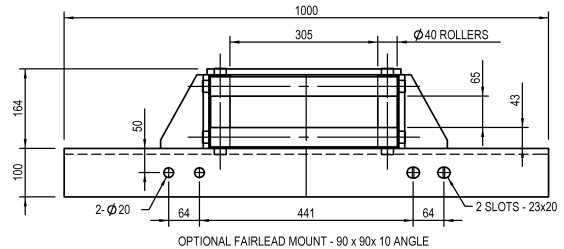
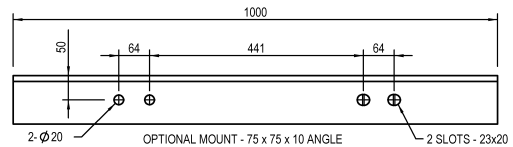
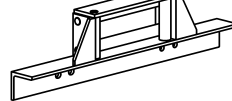
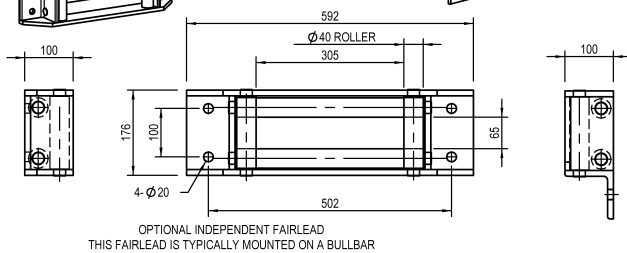
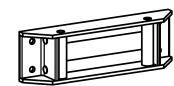
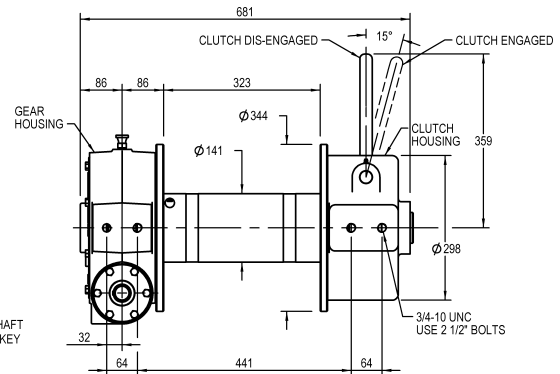
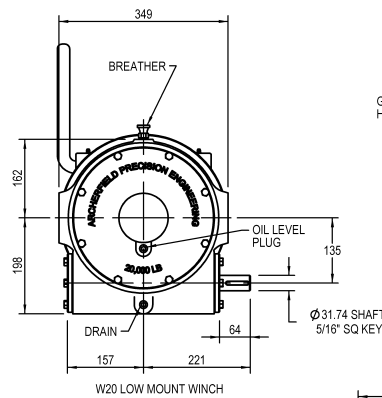
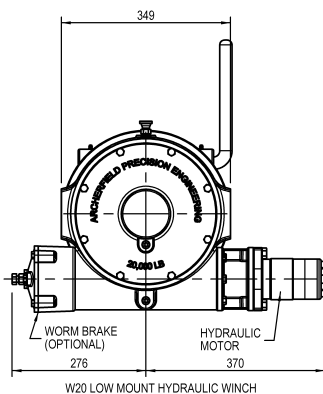

Your Winch Industries Distributor is:



Winch Industries Pty Ltd
2 Coin Street
Moorooka Qld 4105
PO Box 206
Acacia Ridge Qld 4110
Ph: (07) 3875 1568
Fx: (07) 3277 4316
www.winch.com.au